



CANFLEX (USA) Inc.

Canflex Series 2 “Sea Slug” Towable Bladder



“OPERATIONAL GUIDELINES”

CANFLEX (USA) INC
412-30th. Street -P.O. Box 1014-ANACORTES WASHINGTON 98221
Tel: (206) 282-8233 or (800) 544-8356 - Fax: (206) 282 5933 or (800) 635-8992
canflex@direct.ca www.canflexinc.com

Table of Contents

CANFLEX Series 2 "Sea Slug" Data Sheet.....	2
A) Introduction.....	3
B) Parts and Accessories Installation.....	3-8
C) Launching the Sea Slug	8-9
D) Filling the Sea Slug	9-10
E) Towing the Sea Slug	10-13
F) Offloading the Sea Slug	13-16
G) Using the Sea Slug for Storage on Land	17
H) Cleaning the Sea slug	17
I) Retrieving the Sea Slug	17-18
J) Repacking the Sea Slug.....	18-19
K) Maintenance/Long Term Storage/ Inspection	19
L) Repair.....	20

APPENDIX A: SPECIFICATIONS & CHECK LIST

CANFLEX Series 2 "Sea Slug" Data Sheet

Model	Capacity	Length	Diameter	Auxiliary Floatation	Dry Weight	Draft	Shipping Volume
	m ³	m	m	Kg	Kg	m	M ³
	USG	ft	ft	lb	lb	ft	ft ³
FCB-125	50	14.3	2.3	1,012	818	2.06	6
	13,200	47	7.5	2,230	1800	6.71	211
FCB-250	100	20	2.8	1,579	1088	2.50	6.8
	26,400	66	9.2	3,480	2400	8.23	240
FCB-400	150	20.4	3.5	1,594	1150	3.13	7.6
	39,650	67	11.3	3,515	2540	10.11	268
FCB-500	200	22.6	3.7	1,769	1270	3.31	8.4
	52,850	74.3	12.2	3,900	2800	10.91	297
FCB-650	250	27.1	3.7	2,023	1470	3.31	9.2
	66,000	88.9	12.2	4,460	3250	10.91	325

Fittings/Valves on the Series 2" Sea Slugs":

[Note: fittings may vary slightly based on customer preference or contract agreement]

(All flanges are cast marine grade anodized marine grade aluminum)

One: 25.5" or 16" center connection for a submersible pump

Two: 4" fill/off load flange connection (top NPT, stern male camlock)

One: 6" NPT fill/off load flange connection

One: 2' pressure relief valve

One: 2" or 2.5" decant connection

Two: 4" PVC ball valve for connection to an NPT flange

One: Internal nose cone air bladder to add floatation to the bow (filled via bow air fill check valve)

Standard Accessories for the Series 2 "Sea Slugs":

[Note: accessories may vary slightly based on customer preference or contract agreement]

1. Towing bridle and stainless steel towing connections
2. Towing line
3. Optional aluminum shipping container with collapsible side and replaceable liner
4. Repair Kit
5. Flexible PVC drogue w/ drogue line and float
6. Float w/ lanyard to connect to the stern
7. Non collapsible hose section for connection to the stern-cone flange

A) Introduction

The Canflex Sea Slug Fluid Containment Bladder (FCB) is used by private and government organizations for storage and transportation of recovered fluid required for filling and towing operations at sea. The Sea Slugs can also be used for fluid storage on land.

The Sea Slugs are constructed using high strength PVC coated polyester material, air floatation, stainless steel towing gear, and marine grade aluminum fittings. The fabric is joined using state of the art radio frequency welding machines resulting in seam strength equal or greater than the parent fabric.

There are several 3" and/or 4" NPT threaded connections on the Sea Slug where caps and ball valves are supplied for attachment. Any of these connections can be used for filling, off loading or decanting. There is also a 25.50" or 16" ID top center connection where a submersible pump can be inserted.

Other unique features include air tube floatation panels, an internal bow inflatable air bladder to elevate the bow section during tow, and detachable drogue to improve towing safety.

B) Parts and accessories installation

Deployment methods will vary depending on the user handling equipment available and facility layout. The bladder can be transported to a spill site via air or land craft, or it can be deployed at the dock and towed to the spill site.

When deploying the Sea Slug four to five people should be available to help. Any sharp or jagged objects on or near the deployment deck should be removed or safeguarded. If there is a tarp available it should be laid on the deployment deck for the Sea Slug to lie on.

Removing the Sea Slug from its Container:

We highly recommend the optional Canflex USA aluminum shipping / storage container for the "Sea Slugs". The aluminum containers have a collapsible side, and a removable liner. The containers are constructed to be lifted by forklift or crane hoisted and is sized to fit shipping pallet on large aircraft. If available, a crane, davit arm, forklift, or other lifting device can be used to lift the container top off and place it aside. The Sea Slug lies within a cargo inside the aluminum storage container.

Removed all the accessories and parts from the inside of the container and placed them away from the Sea Slug's deployment area.

Lift the Sea Slug from the container by its cargo net lifting straps and place it on a suitable deck.

PICTURES 1, 2 & 3 REMOVING THE BLADDER FROM THE CONTAINER



PICTURES 4, TO 8 UNROLL THE BLADDER ON DECK

The bladder is rolled and sent by CANFLEX inside the container. The user has to roll back the bladder in the same way as it was sent, so it is ready to be used.

When unrolling the Sea Slug two to three people should be available to help



Unroll the bladder out flat and open the sides of the bladder to attach the connections.



Attach the Top 4" PVC BALL VALVE:

This valve has male and female cam-lock connections and is assembled to the 4" connection located on the top stern end. This valve is used as a "VENT"; however it also can be used as a filling connection when the 6" connection is used as a vent.

TOP 4" BALL VALVE ALWAYS OPEN WHEN FILLING THE "SEA SLUG" SEE PICTURE 9



Attach the Stern 4" PVC BALL VALVE:

This valve has male and female cam-lock connections and is connected to the 4" stern non-collapsible hose "suction hose". This hose is then connected to the 4" cam-lock connection located at the stern end of the bladder. Close the stern ball valve and secured it to one of the triangular grips located at the stern before getting under way.

This assembly is used as an **OFFLOADING** connection.

STERN 4" BALL VALVE ALWAYS CLOSED WHEN FILLING THE "SEA SLUG" SEE PICTURE 10 & 11



Attached the 6" butterfly valve w/ swivel

This valve has male and female cam-lock connections and is assembled to the 6" connection located on the top bow end of the bladder. This valve is used as a "**FILLING/ OFFLOADING**" however it also can be used as a Vent when the 4" connection is used as a filling connection.

Attach a filling hose with a capped end to one of the NPT flanges before the Sea Slug is deployed. Connection of this hose before deployment allows one to access the filling connection easily. Note when the bladder is empty the top connections may be slightly beneath the water surface making it difficult to access a fill connection if the filling hose is not attached ahead of time. These connections rise above the water surface as the Sea Slug is filled.

TOP 6" VALVE ALWAYS OPEN WHEN FILLING THE "SEA SLUG" SEE PICTURE 12 & 13



Leave the top pressure relief valve uncovered and make sure the top center connection is tightened in place.

PICTURES 14 & 15



Place the PVC caps on any unused connections (i.e. 3" decant connection)

SAFETY ISSUE # 1
Leave the 2" pressure relief valve uncovered.

Inflate the Bow Air Chamber:

There is an inflatable bow air flotation chamber in the bow cone section of the Sea Slug. When inflated this air chamber provides flotation for the bow section and improves the towing performance. Note that the air tube chambers welded to each side of the Sea Slug provide more than enough flotation for this unit; the bow air chamber is added for user convenience, and for improved towing performance.

The bow air chamber is inflated via the bow end cone NPT flange. There is a check valve in this flange that allows air to flow in, but not out. Remove the cap from the bow flange and closed the Monsun valve before inflating any of the air chambers. SEE PICTURE 16.

This air chamber can be inflated via a standard leaf blower, or the hand pump. **SEE PICTURES 17 & 18.** The discharge hose from most blowers will fit sufficiently inside the bow end cone flange to inflate the chamber. If the discharge hose to the inflation unit does not fit properly, use tape to make a seal between the blower and the NPT flange. A hand pump is supplied to inflate the nose cone air bladder.

Note: Replace the PVC cap when inflation is complete.



Inflating the Floatation Tubes:

While the Sea Slug is laying out flat, attach the air filler manifold to the six Monsun valves. The manifold was designed to inflate all six tubes at once. There is a gauge and a hose adapter to attach the ship's air source. The manifold attaches to the Monsun valves located at the Tow end of the floatation tubes. The Monsun valves located at the Stern end of the tubes **MUST** have the caps on and tightened. Once the tubes have been inflated to four (4) PSI, remove the manifold and replace the Monsun caps. As an alternative, the six air chambers can be also inflated via the manual pump or leave blower.

PICTURES 19, 20 & 21: LATERAL AIR CHAMBERS INFLATION BY THREE DIFFERENT METHODS:

Ship's air source with manifold

Manual Hand Pump

Backpack Leave Air Blower



Connect Stern Floatation:

There is a 27" buoy provided to keep the Sea Slug stern afloat when it is empty or partially filled in the water. Connect this buoy to the aft eyebolt on the end cone plate. Make sure the float has a very short connection line so it is nearly flush with the stern plate. **PICTURE 22**

Attach the Drogue:

A drogue and a drogue line are included with the Sea Slug. Attach the drogue to the aft eye bolt (same eye bolt where the 27" buoy is connected) with the drogue line provided. The drogue damps lateral oscillation during towing, and assists in slowing the Sea Slug when its towing vessel slows.

This drogue is NOT USED when towing the Sea Slug from the HIP; it is because the 50 ft drogue line could get caught at the ship's propeller. USE the drogue chute when the bladder is going to be towed from the SHIP'S STERN. (See more at SECTION E: Towing the Sea Slug)

Note: It is not necessary to use the drogue when the Sea Slug is empty, although one may choose to do so. It is good practice to connect a small float approx. 10 feet forward of the drogue. The float marks the drogue's position, and it also allows the drogue to be removed if the boat captain wishes to do so (i.e. in very tight quarters, or enclosed harbors).

PICTURE 22 & 23: STERN END PREPARATION



Connect Lines :

Lines will help to secure the Sea Slug while it is on the water. Connect lines to the triangular grips and to the 2 shackles with the 5" webbing straps "Belly bands".

Navigation Light:

Keep the navigation light handy if night towing is anticipated. The navigation light is attached after the fluid loading is complete. Thread the bottom shaft of the navigation light to the small threaded connection located between the 4" NPT connection and the relief valve (fore or aft). Then lead the four rubber stretch cords from the connections on the navigation light shaft to the eye connections on the bladder.

C) Launching the Sea Slug

Deploying the Sea Slug from the Stern of the vessel

The Sea Slug can be unrolled from its storage container onto the deck using the collapsible container side. After attaching required fittings, inflating all the air chamber, and securing the 4 corners of the ground sheet, the bladder will be ready for deployment.

Care should be taking to assure the bladder enters the water right side up as the valves and fittings are on the topside. Be sure to remove or cover any sharp objects that rest on or near the deployment surface. If the deck area is abrasive place a tarp beneath the bladder before dragging.

To deploy the bladder by this method the vessel must have a smooth round stern end as shown on the pictures. A towing vessel also should be available. Once that the tow line is attached to the towing vessel and the pulling starts the bladder will be on the water in 5 minutes or less. People working around the bladder should always be aware of where they are standing and if there is any sharp objects that may damaged the bladder.

PICTURES 26 TO 31 LAUNCHING THE BLADDER (FCB-250 "100 m³") FROM THE STERN OF A VESSEL



As an alternative.-

Use a lifting device to lift the bladder by one or both ends, or from the center using the triangular grips, and place it into the water. Apply tension to the towing line and the tether lines to assure that the Sea Slug is deployed with the top flanges up, and with each air tube panel above water. Do not inflate the Sea Slug with air when placing it into the water as the top fittings will roll towards the water surface and possibly broach the bladder. **DO NOT USE THE BELLY BANDS FOR PLACING THE SEA SLUG ON THE WATER, IT IS BECAUSE THE BLADDER WILL FOLD INTO ITSELF AND THE TOP CONNECTIONS WOULD BE COVERED BY THE SEA SLUG.**

SAFETY ISSUE # 2

The Sea Slug should not be air inflated when placed into the water

D) Filling the Sea Slug

Filling through a top or stern NPT Flange:

A filling hose should be connected to the Sea Slug prior to deployment (stern non-collapsible hose can be used as a filling hose as well) **SEE PICTURE 32.** The size of your filling hose will depend on the pump or skimmer outlet size that you fill the Sea Slug with. **Prepare the proper hose connections ahead of time.** Connect your skimmer or other fluid transfer device to the filling hose and begin pumping.

PICTURE 32: CONNECT FILLING HOSE TO THE SEA SLUG BEFORE DEPLOYMENT AND OPEN THE VALVE



SAFETY ISSUE # 3

Top Side Ball Valve Must be Kept Open

“IMPORTANT” When filling the “Sea Slug”, The Top Side Ball Valve Must be Kept Open (SEE PICTURE 33) and monitored to determine a stop filling point. If heavy seas are to be encountered it is best to stop filling the Sea Slug when the unit still has some flexibility to conform to wave motion.

PICTURE 33: OPEN TOP “VENT” VALVE BEFORE FILLING



SAFETY ISSUE # 4

Do not over pressurize the bladder

Be careful not to over pressurize the bladder by leaving the filling pump running after the Sea Slug is full. Sea Slugs are made from very strong fabric and welded with state of the art equipment; however, like any fabric container, they can not take the pressure that most steel pump casings can deliver.

E) Towing the Sea Slug

Towing from the Hip:

When towing from the hip, the Sea Slug should be placed over the side of the vessel. Attach the 1” towline to a forward tie down point. Then attach the 1” line to an aft tie down point. Use the “Belly Bands” (two yellow 5” straps) supplied around the Sea Slug for securing the Sea Slug to the side of the ship when necessary. **DO NOT USE THE TRIANGULAR GRIPS AS TIE DOWN POINTS, USE THE BELLY BANDS.**

SAFETY ISSUE # 5

Each metal triangular grip has a maximum working load of 1000 lbs

PICTURES 34 & 35: SEA SLUG MOORED TO SIDE OF THE VESSEL WITH THE “BELLY BANDS”



PICTURES 36 & 37: TOWING THE SEA SLUG FROM THE HIP



SAFETY ISSUE # 6

- **The Sea Slug is capable of being towed at a relative speed of 6 knots (including current) when 100% full of fresh water and 12+ knots when empty. Variable sea conditions will require adjustment of the towing speed to obtain the optimum towing performance.**
- **Make sure nose cone bladder and buoyancy pockets are inflated**

Towing from the Stern of Vessel:

The Sea Slug comes with a 100 ft (30 m) tow line attached to a six point towing bridle connected to the bow end cone via stainless steel eyebolts. To tow the bladder, simply connect the towline to the vessel and begin towing. (SEE PICTURES 38 & 39).

PICTURES 38 & 39: TOWING THE SEA SLUG FROM THE REAR



When 100% full, the relative (including current) towing speed should not exceed 6 knots. If the Sea Slug is 100% full and the relative towing speed exceeds 6 knots, the bladder may be forced beneath the water surface. If this happens, the user should immediately slow the vessel allowing the bladder to rise to the surface again.

Adhere to safe navigation practices avoiding obstacles and assure that the water is deep enough to avoid grounded. When the Sea Slug is fully loaded with fresh water, the draft is generally about 90% of its maximum diameter. For example, when fully loaded with fresh water the FCB-125 has a draft of approx. 5 feet (SEE PICTURES 40 & 41). The speed of tow should be reduced in shallow waters for safety and the same will apply for the FCB-250.

PICTURES 40 & 41: SEA SLUG FULLY LOADED



The vessel operator should keep in mind that the drogue trails approx. 50 feet behind the Sea Slug. Be sure that the drogue will not snag any obstacles when leaving a berth, or get caught at the boat's propeller (SEE PICTURE 42 & 43)

Note: It is not necessary to use the drogue when the Sea Slug is empty, although one may choose to do so. It is good practice to connect a small float approx. 10 feet in from the drogue. The float marks the drogue's position and it also allows the drogue to be removed and reattached if desired.

PICTURES 42 & 43: SEA SLUG TOWED FROM THE STERN WITH DROGUE CHUTE



F) Offloading the Sea Slug/Decanting

Off loading via a top NPT flange and/or stern suction hose:

The Series 2 "Sea Slugs" have 4" and 6" threaded connections on its top panel and non-collapsible suction hose at the stern end. A common method of off loading and decanting the Sea Slug is to simply attach a suction hose to one of the top or end connections and begin pumping out the fluid. The suction end of the off loading hose should have a tight connection (i.e. camlock with an o-ring) for proper suction. **Prepare the proper hose connections ahead of time.**

PICTURES 44, 45 & 46: OFFLOADING THE SEA SLUG THROUGH THE STERN SUCTION HOSE WITH A SUBMERSIBLE PUMP

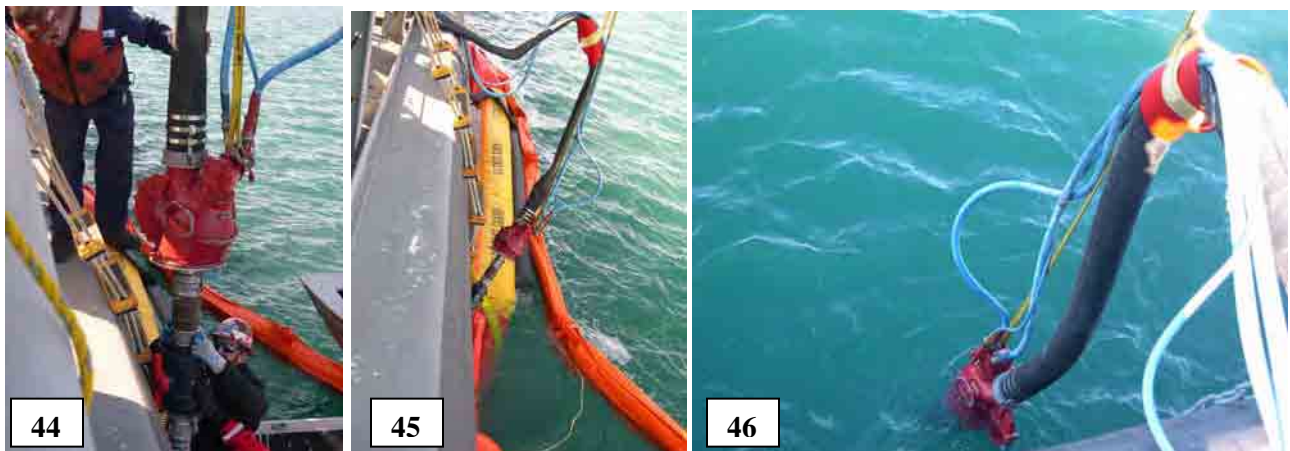

PICTURES 47 & 48: OFFLOADING THE SEA SLUG THROUGH THE STERN SUCTION HOSE AND A TOP 4" NPT FITTING WITH TWO SPATE-75 NON-SUBMERSIBLE PUMP



Off loading via the Decanting Connection (if available):

To off load fluid simply attach a suction pump to the camlock on the decant hose and begin pumping. There is a 2" or 2.5" camlock decanting fitting on the top panel of the Sea Slug and a weighted internal non-collapsible extension hose connected to this fitting. Decanting the water and off loading oil from the Sea Slug are basically the same operation. The only difference is, when decanting, the intake of the decanting hose should reach the bottom layer of fluid within the Sea Slug.

A crane can be used to lift one end of the bladder, to assist the flow of oil to an off loading point.

SAFETY ISSUE # 7

The bladder should not be lifted fully out of the water when it is loaded with fluid; instead, use incremental lifts of the crane to assist flow toward the suction pump off loading point.

Note: A short section of non-collapsible hose should be connected to the stern NPT flange before deployment. This allows the user to remove the final amounts of fluid from the stern end while the blow end is being incrementally lifter from the water.

SAFETY ISSUE # 8

The metal triangular grips along the top of the Sea Slug are not to be used for lifting when the bag is full or partially full.

SAFETY ISSUE # 9

When offloading fluids by lifting the Sea Slug from the nose cone the crane operator needs to be made aware of the maximum lifting:

- If the Sea Slug is lifted with a 90° angle straight vertical pull, the lifting load should not exceed “20,000 lbs”. Picture 50
- If the Sea Slug is lifted between a *45° and 60° angle, the lifting load should not exceed “3,000 lbs”. Picture 49

* When the Sea Slug is lifted between a 45° and 60° angle, only 2 out of 6 eye bolts are being pulled, therefore the overall yield strength decreased from 20,000 lbs to 6,000 lbs.

Canflex (USA), Inc also recommends to do not lift the Sea Slug with less than a 45° angle because of decreased yield strength.

PICTURES 49 & 50: LIFTING THE SEA SLUG

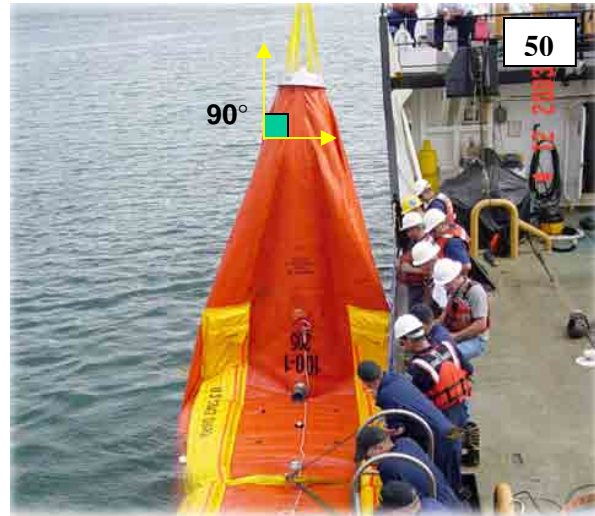

Off loading via Submersible Pump:

There is a 25.50" or 16.25" ID port centered at the top center position. A submersible pumps with an outside diameter of less than 25.50" or 16.25" can be lowered into the top center connection of the Sea slug. Canflex can adapt ANY centrifugal or Archimedes' screw submersible pump into the adaptation cap.

Submersible Pump Offloading with Adaptation Cap RECOMMENDED: This method uses a Canflex manufactured water tight adaption cap with throughput connections for the pump discharge hose and the pump hydraulic hoses.

After the Sea Slug has been almost complete filled, remove the 25.50" or 16.25" blank cap and lower the pump assembly into the Sea Slug and close the adaption cap. A small boat can be used as a platform or the ship's crane to lower the pump. When ready, connect your hydraulic and discharge hose to the adaption cap, and begin off loading with the pump. **Prepare the proper connections ahead of time.**

NOTE: Read the submersible pump and power pack manuals for proper pump handling.

PICTURES 51 TO 55: INSTALLING THE CANFLEX ADAPTATION CAP WITH SUBMERSIBLE PUMP INSIDE THE SEA SLUG

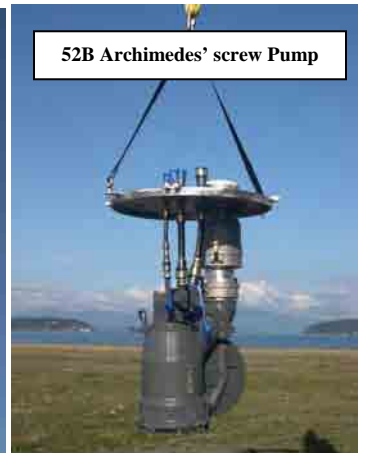

PICTURES 56, 57 & 58: OFFLOADING THE SEA SLUG VIA THE SUBMERSIBLE PUMP



G) Using the Sea Slug for Storage on Land

Follow the same filling and off loading procedures for land use of the Canflex Sea Slug. Take extra caution to assure that the Sea Slug is not resting on any sharp objects, as fluid stored in the Sea Slug will press the bottom fabric against any sharp object beneath.

Note 1: Do not tow Sea Slug on land.

Note 2: When being filled on land, the bottom of the Sea Slug must remain flat so it does not have a tendency to roll. Stop filling the Sea Slug before the bottom becomes too round; thus causing instability. The Sea Slug can be filled to approx. 80% capacity on land.

H) Cleaning the Sea Slug

The Sea Slug should be cleaned by partially filling the bladder with water and detergent and agitating the mixture by rolling the bladder back and forth on a non-abrasive deck. Empty the Sea Slug and repeat the process if necessary.

The top access fittings can be used to inject the water. A simple fitting on a water discharge hose would allow the water or detergent injection while the Sea Slug is inflated with air. Be sure not to fully inflate the bladder with air while it is in the water.

High pressure water jets and detergent can be used to clean the outside of the Sea Slug and all the aluminum fittings and stainless steel towing gear. **Standard decontamination practices for fluid run-off during cleaning should be followed.**

I) Retrieving the Sea Slug

Retrieving the Sea Slug from the Stern of the vessel

Placed the ground sheet on the deck of the vessel and secured its 4 corners.

Be sure to remove or cover any sharp objects that rest on or near the deployment surface. If the deck area is abrasive place a tarp beneath the bladder before dragging.

To retrieve the bladder by this method the vessel must have a smooth round stern end as shown on the pictures. A winch or crane also should be available.

Once the bladder is empty and the tow line is attached to the winch of the vessel, and the pulling starts, the bladder will be on deck in 5 minutes or less. People working around the bladder should always be aware of where they are standing and if there is any sharp objects that may damaged the bladder.

PICTURES 59 TO 64: RETRIEVING THE BLADDER (FCB-250 100 m³) FROM THE STERN OF A VESSEL

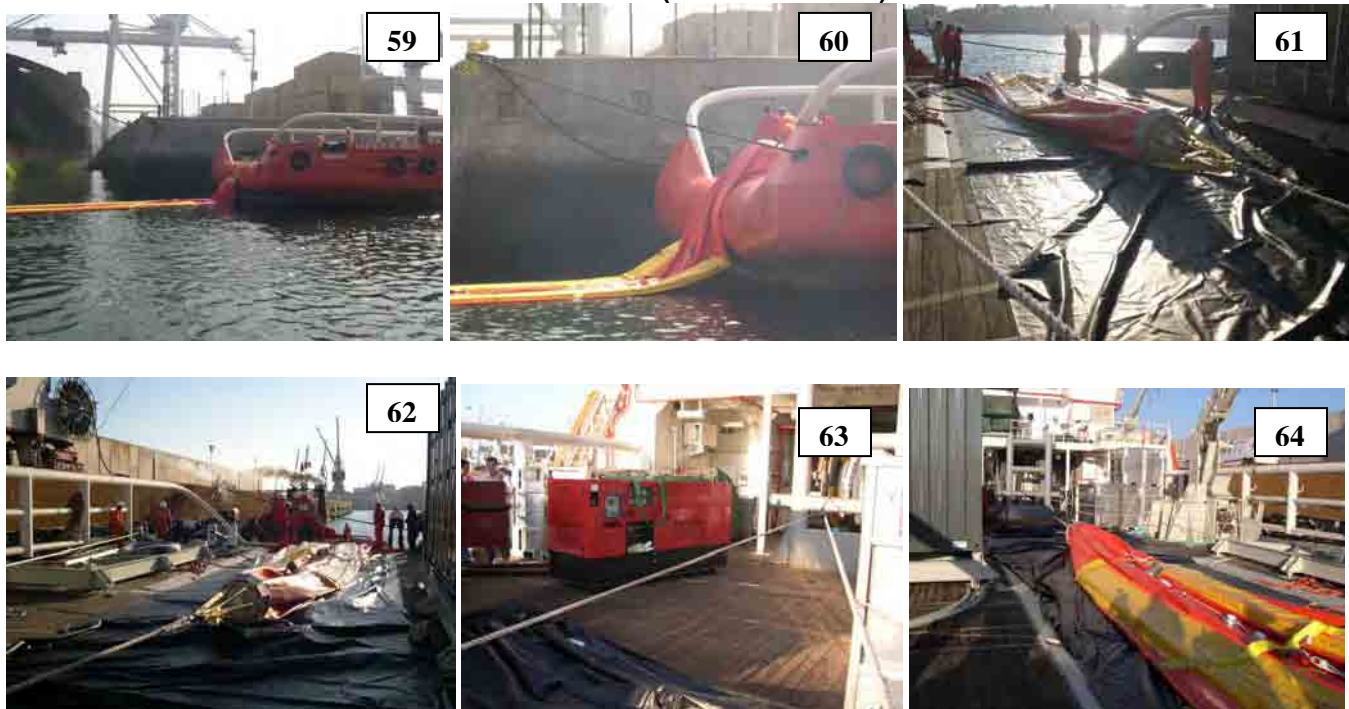

As an alternative.-

Placed the ground sheet on the deck of the vessel or dock area, and remove or cover any sharp objects that rest on or near the ground sheet.

Use a lifting device (i.e. ship's crane) to lift the bladder by the "belly bands", the triangular grips located at the ends, or both. **The SEA SLUG must be empty before retrieving it from the water.**

PICTURES 65 TO 66: RETRIEVING THE BLADDER FROM THE SIDE OF A VESSEL



J) Repackaging the Sea slug

The Sea Slug should be clean and dry before repackaging. Lay the Sea Slug on a non-abrasive deck and remove ball valves and end caps. Remove any residual air in the bladder by using the suction end of a vacuum or blower.

To repackage the Sea slug, first cap and cover all the top fitting with the provided PVC caps and the square pieces of PVC/TPU material. Fold the sides of the Sea Slug over to the top connections as well as the ground sheet. The 4" stern connection and the Monsun valves located at the stern end should be open, so air can be relief as the bladder is rolled.

PICTURES 67, 68 & 69: PREPARING THE SEA SLUG FOR REPACKING



Start rolling the bladder from the bow “tow end” to stern end. Place the rolled Sea Slug in the center of the cargo net and lift into the container. When rolling the Sea Slug four to five people should be available to help.

PICTURES 70 TO 75: ROLLING AND REPACKING THE SEA SLUG

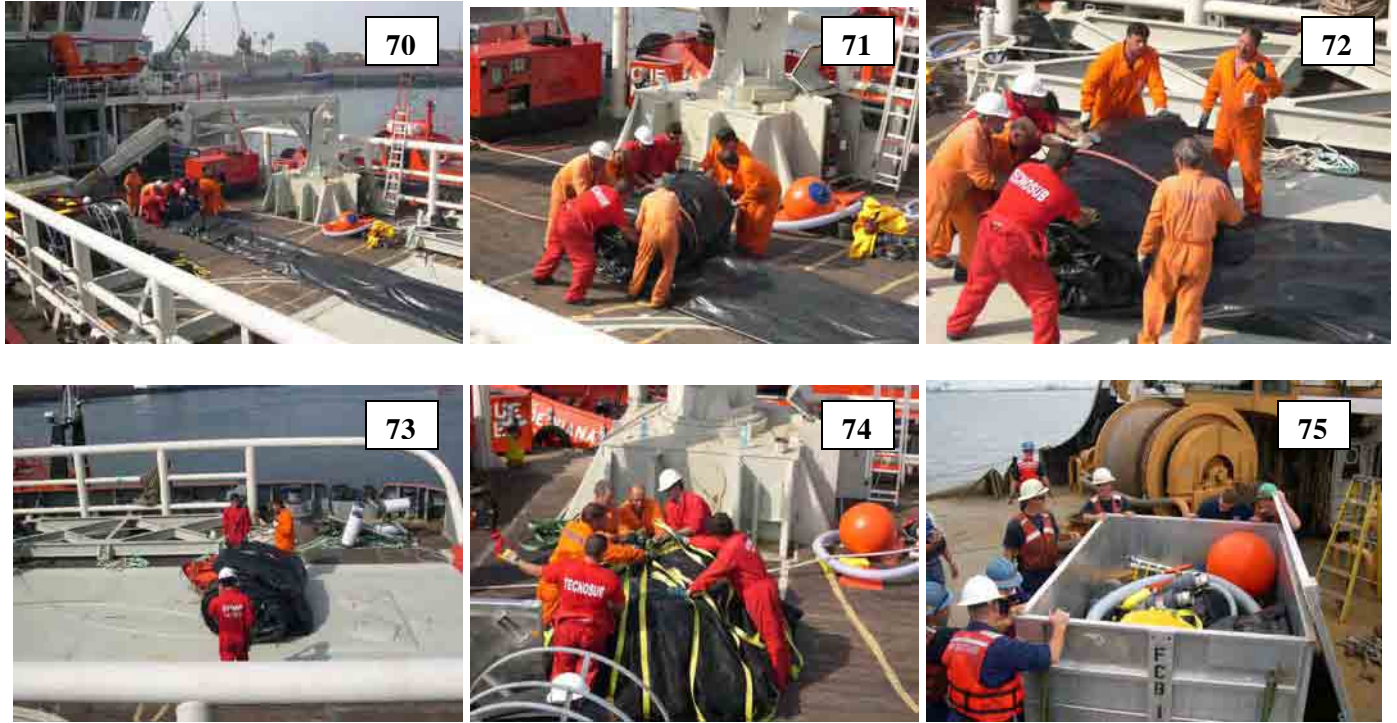

As an alternative.-

If a crane is available, pick up the tow end and fold back upon it until the tow end is lined up with the stern end. Pick up both ends at the same time and fold the Sea Slug back on itself to achieve an 8-foot length. Repeat the folding process until the Sea Slug is completely folded with the nose cones located on top. Place the folded Sea Slug in the center of the cargo net and lift into container.

SAFETY ISSUE # 10
Do not store the aluminum shipping on-site storage container in direct sunlight

K) Maintenance/Long Term Storage/Inspection

Clean after use, and store dry. Storing the Sea Slug wet should not damage the fabric; however, micro organisms may cause a foul smell after time.

Perform a visual inspection after each use of the Sea Slug. Check fabric for tears or abrasions. Also check all hardware for corrosion or structural damage. If the Sea Slug is not used, break it out annually, inflate it, and then perform a visual inspection.

L) Repair

If for some reason the Sea Slug coated fabric has become holed or damaged, repairs should be affected before the bag is re-stored so that it is ready for instant use when next required.

For minor repairs use following repair procedures:

- Step 1) Use a patch two to three times the size of a small hole or tear.
- Step 2) Clean the damaged area with solvent such as lacquer thinner or acetone.
- Step 3) Apply the PVC adhesive to the patch and to the body of the bladder.
- Step 4) With the damage area cleaned, dry, and resting on a hard flat surface, apply the patch over the damaged area
- Step 5) Use the roller to press out any trapped air.
- Step 6) Allow 12 hours before re-use or storage.

Please Consult Canflex or your Supplier if extensive repairs are required

CANFLEX (USA) INC
412-30th. Street -P.O. Box 1014-ANACORTES WASHINGTON 98221
Tel: (206) 282-8233 or (800) 544-8356 - Fax: (206) 282 5933 or (800) 635-8992
canflex@direct.ca www.canflexinc.com

**APPENDIX A:
SPECIFICATIONS & CHECK LIST**

July, 2007

Specification: Canflex” Sea Slug” FCB-250 Towable Bladders for USCG

1.0 General Construction

The Towable Fluid Storage Bladder (TFSB) has a cylindrical main body and matching conical ends shape, and its bow end is inclined to improve towing performance.

The material used in fabrication of the bladder is an **89oz/sq yard (3024 g/sqm)** "Oil & Fuel Resistant" Polyurethane TPU/ PVC blend coated, high tenacity 2057 lbf/in (18000 N/5cm) , polyester fabric. The fabric is orange in color with strength characteristics shown in Table-2 below. All seams used to construct the TFSB are R/F welded with a 4" die. **No sewing or gluing is used on the construction of the TFSB.** The resulting seam strength of the welds is equal to or greater than the strength of the parent fabric.

Table 1. - FCB-250 Characteristics

Model	Capacity	Length	Diameter	Auxiliary Floatation	*Dry Weight	Draft	Shipping Volume
	m ³	m	m	Kg	Kg	m	m ³
	USG	ft	ft	lb	lb	ft	ft ³
FCB-250	100	20	2.8	1,579	1088	2.50	6.8
	26,400	66	9.2	3,480	2400	8.23	240

** Dry weight with accessories*

Table 2 - Material Strength Results

Oil & Fuel Resistant Polyurethane TPU/PVC Blend Coated High Tenacity Polyester Fabric

Data Type	Test Method	Result
Material coating	TPU/PVC blended coating	High Tenacity Polyester fabric
Weight of base fabric	DIN 5384 or equiv	38.3 oz/sq.yd.(1300 g/sqm)
Weight of Coated Fabric	DIN 53853 or equiv	89 oz/ yd ² (3,024 g/ m ²)
Tensile Strength	DIN 53354 or equiv.	2057 lbf/in (18000 N/5cm)
Tear Strength (tongue suter)	FTMS 191556 or equiv.	669 lbf (2975 N)
Cold Crack	DIN 53361 or equiv.	-22 deg F (-30 deg C)
Heat Resistance	IVK-Method or equiv.	+ 160 deg F (80 deg C)
Bending Resistance	DIN 53359 or equiv.	minimum 100,000 knits
Ultra Violet	DIN 54404 or equiv.	7 of possible 8 Black color (8 of possible 8)
Adhesion	DIN 53357	36 lbf/in (313 N/5cm)
Special Finish	Urethane/PVC Blended	Oil & fuel resistant coating

CANFLEX (USA) INC.

412 - 30th Street – P.O. Box 1014 - ANACORTES, WASHINGTON 98221
 Tel: (206) 282-8233 or (800) 544-8356 – Fax: (206) 282-5933 or (800) 635-6992
canflex@direct.ca www.canflexinc.com



1.1 General Specifications.-

Tow and Stern End Construction

The ends of the TFSB are constructed so the towing force is evenly distributed through the fabric panels of the product, rather than distributing the tow forces throughout the hardware connecting the end fittings. This increases the product longevity.

The bow end is inclined to improve towing performance, and has a vertical SWL capacity of 20,000 lbs. The TFSB is capable of being towed at a relative speed of 3 knots when 100% full of fresh water and 12+ knots when empty.

Air filled floatation buoyancy floats.-

Each TFSB has (2) **Air filled floatation buoyancy floats**. Each float consists of (6) **air chambers**, giving the float a low profile rectangular shape. Also, the use of multiple air chambers creates a high safety margin in case of a puncture or damage caused air leak in one of the chambers.

The floats are enclosed in water tight, covered pockets that run the full length of the bladder along the upper sides. Float pockets are constructed using highly visible “Int. Yellow” oil & fuel resistant grade 48 oz. sq. yd. (1622 g/ m²) TPU/ PVC blend of coated, high tenacity, polyester fabric as shown in Table-3. For additional night visibility each float has 2” wide light reflective tape welded along the upper edge.

Table 3 - Coated Fabric Material Cover: Air Inflatable Floats

Data Type	Test Method	Result
Color: Yellow	TPU/PVC blend coating	High tenacity polyester fabric
Material coating	TPU/PVC blend coating	High tenacity polyester fabric
Weight of base fabric	DIN 5384 or equiv	13 oz/ yd ² (440 g/ m ²)
Weight of Coated Fabric	DIN 53853 or equiv	48 oz/ yd ² (1622 g/ m ²)
Tensile Strength	DIN 53354 or equiv.	924 lbf/in (8090N/5cm)
Tear Strength (tongue suter)	FTMS 191556 or equiv.	350lbf (1553 N)
Cold Crack	DIN 53361 or equiv.	-22 deg F (-30 deg C)
Heat Resistance	IVK-Method or equiv.	+ 160 deg F (80 deg C)
Bending Resistance	DIN 53359 or equiv.	minimum 100,000 knits
Ultra Violet	DIN 54404 or equiv.	7 of possible 8 Black color (8 of possible 8)
Adhesion	DIN 53357	20 lbf/in (170 N/5cm)
Puncture Resistance	Fed. Std. 101-2031	440 lbs (200 Kg)
Abrasion Resistance	ASTM 3389 (TABER D 751 -70° C (160° F) ; 6 hrs	> 7000 Cycles to expose fabric
Special Finish	Urethane/PVC Blended	Oil & fuel resistant coating

2.0 Bow to stern attached Fittings and Items (bolted, welded or shackled)

TFSB fittings are made from cast anodized marine grade aluminum. Nuts, bolts, and washers integral to the fittings are made of stainless steel. The fittings will be bolted through the main body of the Sea Slug to a cast marine grade aluminum backing plate. Each fitting will be mounted on a patch having a greater diameter than the outside diameter of the particular fitting.

- One only tow bridle c/w 1" x 100 ft high strength rope tow line c/w bronze thimble eyes both ends, line is attached to tow bridle with 14 tonne screw pin shackle
- One only 4" NPT male connection c/w PVC cap and lanyard located in center bladder nose cone to enclose bladder and check filler valve below
- One 2" air transfer check valve on the bow end plate for inflating the bow internal air bladder. The check valve is covered with a 2" cap.
- One set double triangles welded to bladder – position top forward
- Four triangles welded on sides of bladder (2 per side) – position top forward. Purpose: Connected via 2" webbing to tow end bridle.
- One only 6" NPT male threaded connection c/w PVC cap and lanyard-function-"to accept 90 degree elbow and butterfly valve assembly for loading of bladder.
- One only navigation light fixture welded to top of bladder. It consists of 1.5" male NPT connections which lie in the center of four welded eyes used to strap the light in place.
- One only 5" webbing lift straps to fit around bladder to help in launch/retrieval of bladder (belly band).
- One only 4" NPT male connection to house 2" pressure relief valve to relieve gaseous vapors pressure c/w PVC cap and lanyard.
- One only triangle welded to top of bladder –forward of large center hatch
- **One 25" ID** cast marine grade aluminum hatch to accept a submersible off loading pump such as DOP-160, DOP-250 or Lamor pump equivalent. The hatch shall be positioned on top of the TFSB, and at the longitudinal center, cap that can be removed by hand shall be provided to cover the hatch opening. This size opening is compatible with submersible screw offloading pumps.
- One only triangle welded to top of bladder-to rear of large center hatch
- Only 4" NPT male connection c/w PVC cap and lanyard- purpose " attach 4" PVC ball valve for vent when filling"
- One only 5" webbing lift straps to fit around bladder to help in launch/retrieval of bladder (belly band).
- One only navigation light fixture welded to top of bladder. It consists of 1.5" male NPT connections which lie in the center of four welded eyes used to strap the light in place.
- One only 3" NPT male connection c/w lanyard – purpose "decant connection"
- One only set triangles welded to top stern of bladder
- One only 4" NPT male connection c/w female camlock located at apex stern cone
- One only stern harness same as bow tow and also c/w 1" x 100 ft high strength rope line c/w bronze thimble eyes both ends, line is attached to harness with 14 tonne screw pin shackle
- One only ½" diameter high strength Safety Line connected to forward triangle with 5/8" SS quick link, this line passes through both triangles located either side of top center hatch and terminates at rear triangle and attached with 5/8" SS quick link.

3.0 List of all unattached accessories included with the bladders to be attached before launch

- One only Drogue to attached to stern of bladder to control forward motion, drogue is c/w ½” x 50 ft rope line w/stainless swivel and rope float. The drogue chute is connected to a swivel which is attached by a quick link to the stern eye bolt.
- One only 27” buoy w/ swivel. Purpose-. Floation to support stern cone
- One only 4” x 15 ft stern suction hose c/w male and female camlocks w/ 4” plug and attached float.
- One water tight 2” ID x 15-ft decanting hose with compression ftg. & threaded connection for connecting to ftg on bladder. It also c/w 2” male and female camlocks connections with plug. This 2” suction / decant hose penetrates to variable depths within the bladder.
- One only 4” x 90 degree elbow w/ male and female cam-lock connections w/ 4” dust cap.
- One 4” female NPT x swivel female cam-lock connection
- One 6” connection to connect to 6” x 90 degree elbow and butterfly valve assembly for loading of bladder with 6” female cam-lock connection.
- One only 4” PVC ball valve c/w cam-lock male and female ftgs to connect to 4” stern suction hose.
- One 6” female camlock x 4” male camlock reducer.
- One only 4” PVC ball valve with cam-locks to connect to 4” NPT threaded connection at top forward position on bladder
- One 5 ft high navigation marker light c/w photo cell , to attach to either forward or aft light mounts welded to top of bladder via 4 bungee cords (31”) supplied

4.0 Additional non-operational items included

- Marine Grade aluminum shipping /storage container
- One only ground sheet
- One only 6” hand pump to inflate nose cone bladder and air floats if powered pump not available
- One certified load rated cargo net to enclose bladders in
- One only air manifold c/w gauge to attached to air float filler valves if desired to inflate float tubes by this method
- Two 20 tonne screw pin shackle
- One maintenance kits that contains following items:
 - 1 x 16 oz. Can PVC patch cement
 - 1 x 24” x 24” coated bladder material
 - 2 x 10” circles same
 - 4 x 7” circles same
 - 4 x 7” circles float cover material
 - 1 knife
 - 1 roller for patch cement
 - 1 strap wrench to remove PVC caps on fittings if required
 - 4 ties
 - User Manual



canflex

(USA), Inc.

5.0 Shipping:

Marine Grade aluminum shipping /storage container

The shipping container is capable of housing the FCB-250 and all accessories. In addition, the container is equipped with:

- One only certified set of container lift harness w/ 5 shackles for overhead lift
- Two air vents
- Cable hoist lifting points
- 2” fluid drain pipe w/ camlock connection
- Locking aluminum lid
- Fork lift slots
- PVC coated fabric replaceable inner liner w/ bungee cord tie downs.

It must be lifted from all sides simultaneously using a forklift. The container has fold down side door(s) and a lockable; lift off top cover. It is equipped with two screened, air vents for ventilation. Equipped with a bottom drain and replaceable inner liner, the container may be used for additional liquid storage once bladder has been removed.

Table 4 - Marine Grade Aluminum Shipping Container Specifications

	Shipping Container for FCB-250
Volume	8.01 m ³ (2116 usg)
Length	8.33 ft (2.54m)
Width	6.25 ft (1.90m)
Height	5.46 ft (1.66m)
Max Weight (empty)	880 lbs/ 399 kilograms

6.0 The following shall be labeled on the TFSB

- Size and function of all top aluminum fitting
- Identification of navigation light mount and anchor points
- All handles (4 on top & 3 on each side) with "MAX SWL 500 LBS" (Maximum Safe Working Load)
- All metal triangular grips with “MAX SWL 1000 LBS”
- Nose cone air valve with "AIR FILL ONLY"
- Tail cone eye bolts with "NOT A LIFT POINT"
- Nose cone with "MAX SWL 20,000 LBS LIFT HARNESS"
- Each float cover shall be silk-screened with “US COAST GUARD” 3 times on each side.

CANFLEX (USA) INC.

412 - 30th Street – P.O. Box 1014 - ANACORTES, WASHINGTON 98221
Tel: (206) 282-8233 or (800) 544-8356 – Fax: (206) 282-5933 or (800) 635-8992
canflex@direct.ca www.canflexinc.com

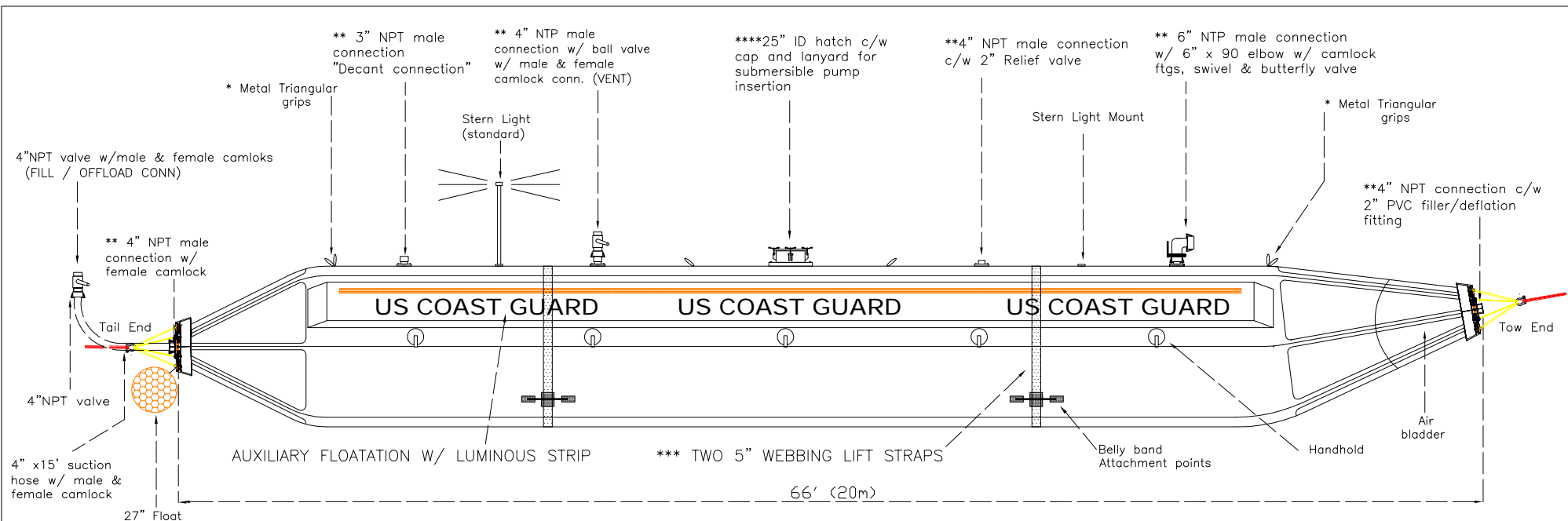

* 4" Triangles made of MARINE GRADE Aluminum 6061-T6. Used only for handling empty bag.
 ** NPT connections c/w corresponding PVC cap and lanyard
 *** 5" Webbing lift straps "BELLY BANDS" attached around bladder. Used as mooring points
 **** The submersible off loading pump such as DOP-160, DOP-50 or Lamor equivalent forms a water tight enclosure when lowered into the bladder through the 25" adaptation cap
 Note: Tow & Stern ends c/w 1" x 100' tow line c/w bronze thimble eyes both ends & 14 tonne screw pin shackle

TAIL END VIEW

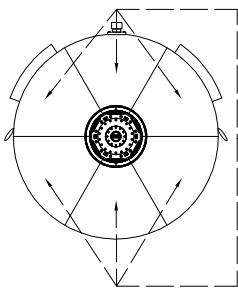

Material:
 Oil & Fuel Resistant" Polyurethane TPU/ PVC
 blend coated, high tenacity, polyester fabric
 Properties:
 89 oz / sqyd (3024 g/sqm)
 Tensile Strength : 2057 lbf/in (18000 N/5cm)

Total weight w/ accessories : 2400 lbs (1088 Kg)

TOW END VIEW

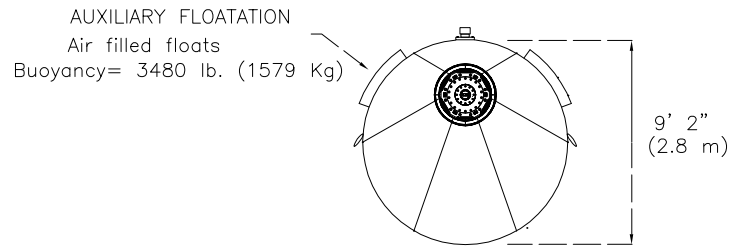

AUXILIARY FLOATATION
 Air filled floats
 Buoyancy= 3480 lb. (1579 Kg)

Cubic Meter	USA Gallons	Liters	Cubic Feet	Barrels		Project: "Sea Slug"		
						Ocean Towable Bladder oil spill recovery		
100	26,400	100,000	3,530	630		Model FCB-250 for USCG		
						SCALE: N.T.S.	APPROVED:	Drawn by: FY
						DATE: 05/12/06		REVISED: 07/01/07
CANFLEX USA INC. PO BOX 1014 , 412 30th St , Anacortes,WA,98221,USA								
Tel:(206)282-8233 or (800)544-8356, Fax: (206)282-5933 or (800)635-8992; Web: www.canflexinc.com								

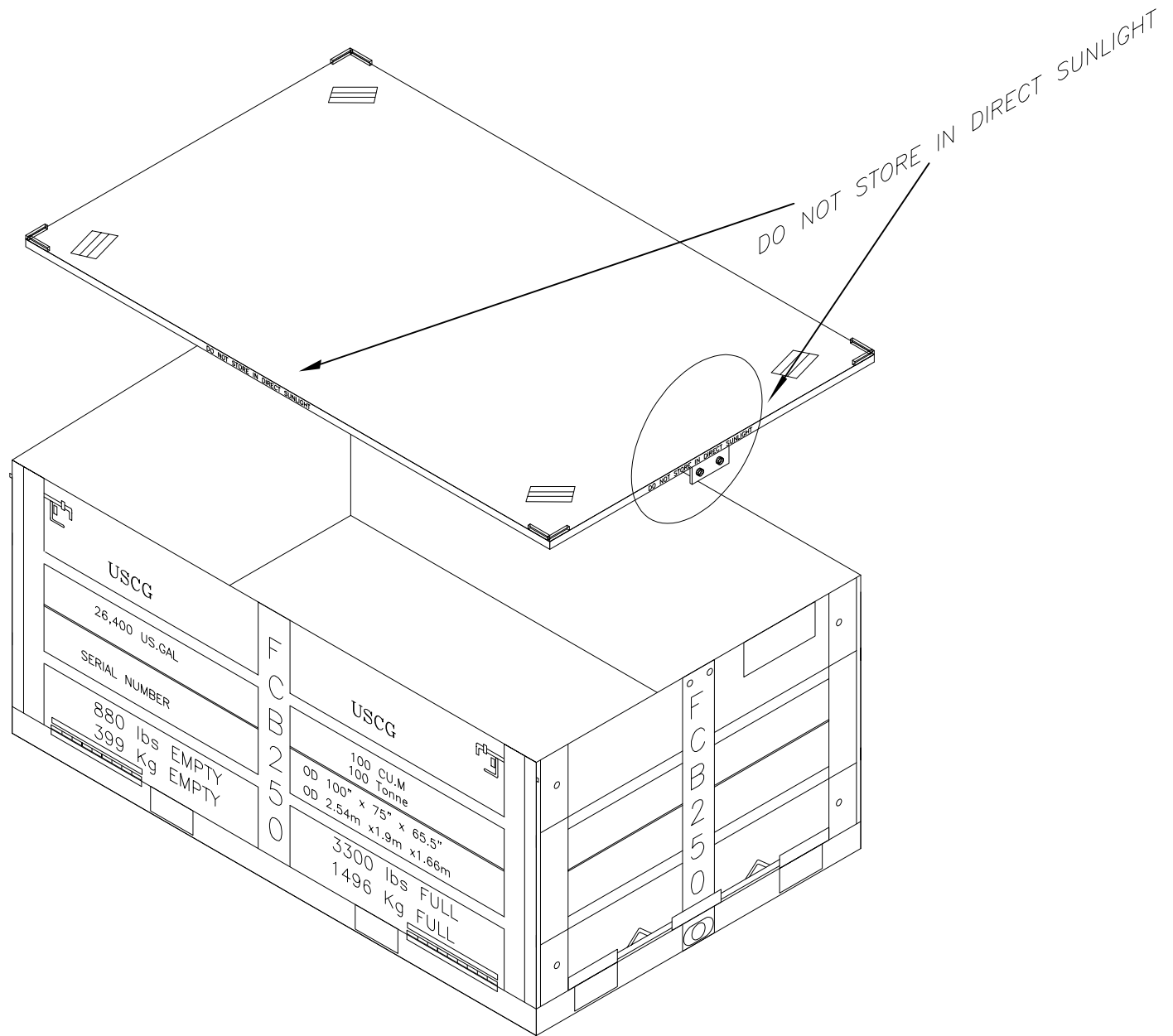

Dimensions:
 FCB- 250 : 1.9 m x 2.54 m x 1.66 m (high)
 or 8.33 ft x 6.25 ft x 5.46 ft (high)
 Material: 100% Anodized Marine Grade Aluminum



Project: FCB-250
 Aluminum Shipping On-site Storage Container

SCALE: N.T.S.	APPROVED:	Drawn by: FY
DATE: 12/22/03		REVISED:

CANFLEX USA, INC. PO BOX 1014 412 30th St. Anacortes, WA. 98221
 Tel: (206) 282-1823 or (800) 544-1835. Fax: (206) 282-5933 or (800) 635-8992

July, 2007

Specification: Canflex “Sea Slug” FCB-125 Towable Bladders for USCG

1.0 General Construction

The Towable Fluid Storage Bladder (TFSB) has a cylindrical main body and matching conical ends shape, and its bow end is inclined to improve towing performance.

The material used in fabrication of the bladder is an **89oz/sq yard (3024 g/sqm)** "Oil & Fuel Resistant" Polyurethane TPU/ PVC blend coated, high tenacity 2057 lbf/in (18000 N/5cm), polyester fabric. The fabric is orange in color with strength characteristics shown in Table-2 below. All seams used to construct the TFSB are R/F welded with a 4" die. **No sewing or gluing is used on the construction of the TFSB.** The resulting seam strength of the welds is equal to or greater than the strength of the parent fabric.

Table 1. - FCB-125 Characteristics

Model	Capacity	Length	Diameter	Auxiliary Floatation	*Dry Weight	Draft	Shipping Volume
	m ³	m	m	Kg	Kg	m	m ³
	USG	ft	ft	lb	lb	ft	ft ³
FCB-125	50	14.3	2.3	1,012	818	2.06	6
	13,200	47	7.5	2,230	1800	6.71	211

** Dry weight with accessories*

Table 2 - Material Strength Results

Oil & Fuel Resistant Polyurethane TPU/PVC Blend Coated High Tenacity Polyester Fabric

Data Type	Test Method	Result
Material coating	TPU/PVC blended coating	High Tenacity Polyester fabric
Weight of base fabric	DIN 5384 or equiv	38.3 oz/sq.yd.(1300 g/sqm)
Weight of Coated Fabric	DIN 53853 or equiv	89 oz/ yd ² (3,024 g/ m ²)
Tensile Strength	DIN 53354 or equiv.	2057 lbf/in (18000 N/5cm)
Tear Strength (tongue suter)	FTMS 191556 or equiv.	669 lbf (2975 N)
Cold Crack	DIN 53361 or equiv.	-22 deg F (-30 deg C)
Heat Resistance	IVK-Method or equiv.	+ 160 deg F (80 deg C)
Bending Resistance	DIN 53359 or equiv.	minimum 100,000 knits
Ultra Violet	DIN 54404 or equiv.	7 of possible 8 Black color (8 of possible 8)
Adhesion	DIN 53357	36 lbf/in (313 N/5cm)
Special Finish	Urethane/PVC Blended	Oil & fuel resistant coating

CANFLEX (USA) INC.

412 - 30th Street – P.O. Box 1014 - ANACORTES, WASHINGTON 98221
 Tel: (206) 282-8233 or (800) 544-8356 – Fax: (206) 282-5933 or (800) 635-6992
canflex@direct.ca www.canflexinc.com

1.1 General Specifications.-

Tow and Stern End Construction

The ends of the TFSB are constructed so the towing force is evenly distributed through the fabric panels of the product, rather than distributing the tow forces throughout the hardware connecting the end fittings. This increases the product longevity.

The bow end is inclined to improve towing performance, and has a vertical SWL capacity of 20,000 lbs. The TFSB is capable of being towed at a relative speed of 3 knots when 100% full of fresh water and 12+ knots when empty.

Air filled floatation buoyancy floats.-

Each TFSB has (2) **Air filled floatation buoyancy floats**. Each float consists of (6) **air chambers**, giving the float a low profile rectangular shape. Also, the use of multiple air chambers creates a high safety margin in case of a puncture or damage caused air leak in one of the chambers.

The floats are enclosed in water tight, covered pockets that run the full length of the bladder along the upper sides. Float pockets are constructed using highly visible “Int. Yellow” oil & fuel resistant grade 48 oz. sq. yd. (1622 g/ m²) TPU/ PVC blend of coated, high tenacity, polyester fabric as shown in Table-3. For additional night visibility each float has 2” wide light reflective tape welded along the upper edge.

Table 3 - Coated Fabric Material Cover: Air Inflatable Floats

Data Type	Test Method	Result
Color: Yellow	TPU/PVC blend coating	High tenacity polyester fabric
Material coating	TPU/PVC blend coating	High tenacity polyester fabric
Weight of base fabric	DIN 5384 or equiv	13 oz/ yd ² (440 g/ m ²)
Weight of Coated Fabric	DIN 53853 or equiv	48 oz/ yd ² (1622 g/ m ²)
Tensile Strength	DIN 53354 or equiv.	924 lbf/in (8090N/5cm)
Tear Strength (tongue suter)	FTMS 191556 or equiv.	350lbf (1553 N)
Cold Crack	DIN 53361 or equiv.	-22 deg F (-30 deg C)
Heat Resistance	IVK-Method or equiv.	+ 160 deg F (80 deg C)
Bending Resistance	DIN 53359 or equiv.	minimum 100,000 knits
Ultra Violet	DIN 54404 or equiv.	7 of possible 8 Black color (8 of possible 8)
Adhesion	DIN 53357	20 lbf/in (170 N/5cm)
Puncture Resistance	Fed. Std. 101-2031	440 lbs (200 Kg)
Abrasion Resistance	ASTM 3389 (TABER D 751 -70° C (160° F) ; 6 hrs	> 7000 Cycles to expose fabric
Special Finish	Urethane/PVC Blended	Oil & fuel resistant coating

2.0 Bow to stern attached Fittings and Items (bolted, welded or shackled)

TFSB fittings are made from cast anodized marine grade aluminum. Nuts, bolts, and washers integral to the fittings are made of stainless steel. The fittings will be bolted through the main body of the Sea Slug to a cast marine grade aluminum backing plate. Each fitting will be mounted on a patch having a greater diameter than the outside diameter of the particular fitting.

- One only tow bridle c/w 1" x 100 ft high strength rope tow line c/w bronze thimble eyes both ends, line is attached to tow bridle with 14 tonne screw pin shackle
- One only 4" NPT male connection c/w PVC cap and lanyard located in center bladder nose cone to enclose bladder and check filler valve below
- One 2" air transfer check valve on the bow end plate for inflating the bow internal air bladder. The check valve is covered with a 2" cap.
- One set double triangles welded to bladder – position top forward
- Four triangles welded on sides of bladder (2 per side) – position top forward. Purpose: Connected via 2" webbing to tow end bridle.
- One only 6" NPT male threaded connection c/w PVC cap and lanyard-function-"to accept 90 degree elbow and butterfly valve assembly for loading of bladder.
- One only navigation light fixture welded to top of bladder. It consists of 1.5" male NPT connections which lie in the center of four welded eyes used to strap the light in place.
- One only 5" webbing lift straps to fit around bladder to help in launch/retrieval of bladder (belly band).
- One only 4" NPT male connection to house 2" pressure relief valve to relieve gaseous vapors pressure c/w PVC cap and lanyard.
- One only triangle welded to top of bladder –forward of large center hatch
- **One 25" ID** cast marine grade aluminum hatch to accept a submersible off loading pump such as DOP-160, DOP-250 or Lamor pump equivalent. The hatch shall be positioned on top of the TFSB, and at the longitudinal center, cap that can be removed by hand shall be provided to cover the hatch opening. This size opening is compatible with submersible screw offloading pumps.
- One only triangle welded to top of bladder-to rear of large center hatch
- Only 4" NPT male connection c/w PVC cap and lanyard- purpose " attach 4" PVC ball valve for vent when filling"
- One only 5" webbing lift straps to fit around bladder to help in launch/retrieval of bladder (belly band).
- One only navigation light fixture welded to top of bladder. It consists of 1.5" male NPT connections which lie in the center of four welded eyes used to strap the light in place.
- One only 3" NPT male connection c/w lanyard – purpose "decant connection"
- One only set triangles welded to top stern of bladder
- One only 4" NPT male connection c/w female camlock located at apex stern cone
- One only stern harness same as bow tow and also c/w 1" x 100 ft high strength rope line c/w bronze thimble eyes both ends, line is attached to harness with 14 tonne screw pin shackle
- One only ½" diameter high strength Safety Line connected to forward triangle with 5/8" SS quick link, this line passes through both triangles located either side of top center hatch and terminates at rear triangle and attached with 5/8" SS quick link.



canflex

(USA), Inc.

3.0 List of all unattached accessories included with the bladders to be attached before launch

- One only Drogue to attached to stern of bladder to control forward motion, drogue is c/w 1/2" x 50 ft rope line w/stainless swivel and rope float. The drogue chute is connected to a swivel which is attached by a quick link to the stern eye bolt.
- One only 27" buoy w/ swivel. Purpose-. Floatation to support stern cone
- One only 4" x 15 ft stern suction hose c/w male and female camlocks w/ 4" plug and attached float.
- One water tight 2" ID x 15-ft decanting hose with compression ftg. & threaded connection for connecting to ftg on bladder. It also c/w 2" male and female camlocks connections with plug. This 2" suction / decant hose penetrates to variable depths within the bladder.
- One only 4" x 90 degree elbow w/ male and female cam-lock connections w/ 4" dust cap.
- One 4" female NPT x swivel female cam-lock connection
- One 6" connection to connect to 6" x 90 degree elbow and butterfly valve assembly for loading of bladder with 6" female cam-lock connection.
- One only 4" PVC ball valve c/w cam-lock male and female ftgs to connect to 4" stern suction hose.
- One 6" female camlock x 4" male camlock reducer.
- One only 4" PVC ball valve with cam-locks to connect to 4" NPT threaded connection at top forward position on bladder
- One 5 ft high navigation marker light c/w photo cell , to attach to either forward or aft light mounts welded to top of bladder via 4 bungee cords (31") supplied

4.0 Additional non-operational items included

- Marine Grade aluminum shipping /storage container
- One only ground sheet
- One only 6" hand pump to inflate nose cone bladder and air floats if powered pump not available
- One certified load rated cargo net to enclose bladders in
- One only air manifold c/w gauge to attached to air float filler valves if desired to inflate float tubes by this method
- Two 20 tonne screw pin shackle
- One maintenance kits that contains following items:
 - 1 x 16 oz. Can PVC patch cement
 - 1 x 24" x 24" coated bladder material
 - 2 x 10" circles same
 - 4 x 7" circles same
 - 4 x 7" circles float cover material
 - 1 knife
 - 1 roller for patch cement
 - 1 strap wrench to remove PVC caps on fittings if required
 - 4 ties
 - User Manual



canflex

(USA), Inc.

5.0 Shipping:

Marine Grade aluminum shipping /storage container

The shipping container is capable of housing the FCB and all accessories. In addition, the container is equipped with:

- One only certified set of container lift harness w/ 5 shackles for overhead lift
- Two air vents
- Cable hoist lifting points
- 2” fluid drain pipe w/ camlock connection
- Locking aluminum lid
- Fork lift slots
- PVC coated fabric replaceable inner liner w/ bungee cord tie downs.

It must be lifted from all sides simultaneously using a forklift. The container has fold down side door(s) and a lockable; lift off top cover. It is equipped with two screened, air vents for ventilation. Equipped with a bottom drain and replaceable inner liner, the container may be used for additional liquid storage once bladder has been removed.

Table 4 - Marine Grade Aluminum Shipping Container Specifications

	Shipping Container for FCB-125
Volume	6.63 m ³ (1752 usg)
Length	8.33 ft (2.54m)
Width	6.25 ft (1.90m)
Height	4.79 ft (1.46 m)
Max Weight (empty)	760 lbs/ 344 kilograms

6.0 The following shall be labeled on the TFSB

- Size and function of all top aluminum fitting
- Identification of navigation light mount and anchor points
- All handles (4 on top & 3 on each side) with "MAX SWL 500 LBS" (Maximum Safe Working Load)
- All metal triangular grips with “MAX SWL 1000 LBS”
- Nose cone air valve with "AIR FILL ONLY"
- Tail cone eye bolts with "NOT A LIFT POINT"
- Nose cone with "MAX SWL 20,000 LBS LIFT HARNESS"
- Each float cover shall be silk-screened with “US COAST GUARD” 3 times on each side.

CANFLEX (USA) INC.

412 - 30th Street – P.O. Box 1014 - ANACORTES, WASHINGTON 98221
Tel: (206) 282-8233 or (800) 544-8356 – Fax: (206) 282-5933 or (800) 635-8992
canflex@direct.ca www.canflexinc.com

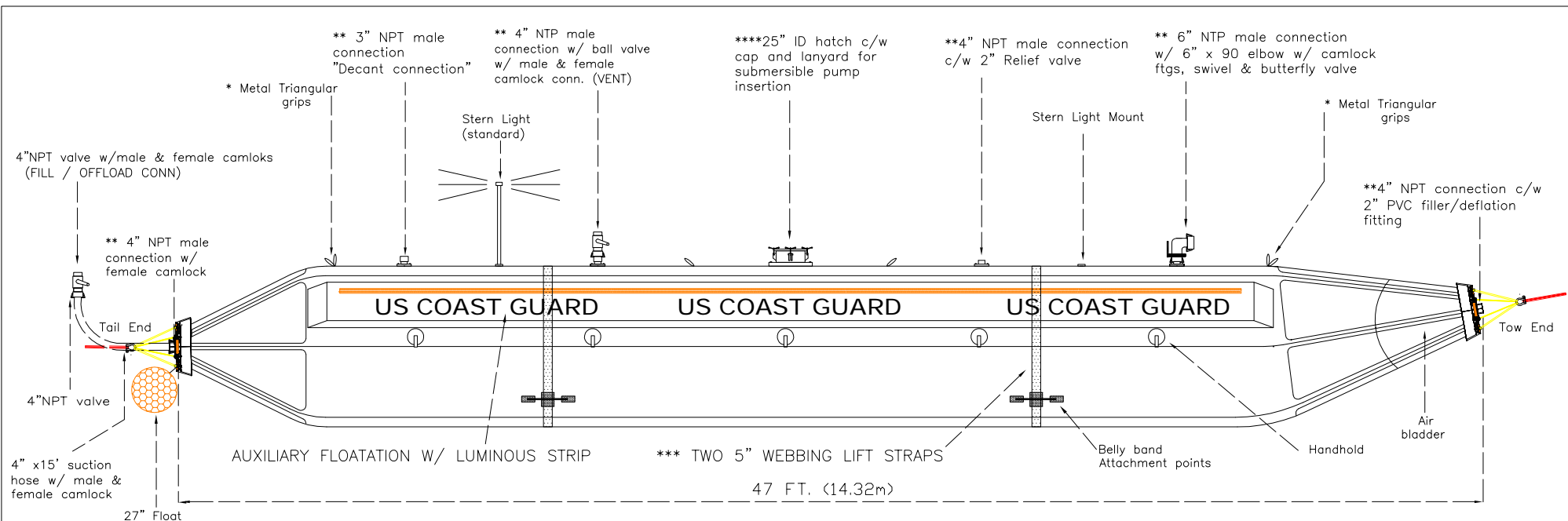

* 4" Triangles made of MARINE GRADE Aluminum 6061-T6. Used only for handling empty bag.
 ** NPT connections c/w corresponding PVC cap and lanyard
 *** 5" Webbing lift straps "BELLY BANDS" attached around bladder. Used as mooring points
 **** The submersible off loading pump such as DOP-160, DOP-50 or Lamor equivalent forms a water tight enclosure when lowered into the bladder through the 25" adaptation cap
 Note: Tow & Stern ends c/w 1" x 100' tow line c/w bronze thimble eyes both ends & 14 tonne screw pin shackle

TAIL END VIEW

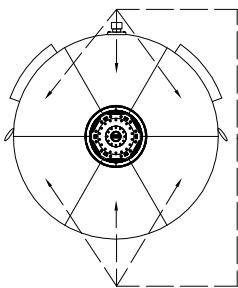

Material:
 Oil & Fuel Resistant" Polyurethane TPU/ PVC
 blend coated, high tenacity, polyester fabric
 Properties:
 89 oz / sqyd (3024 g/sqm)
 Tensile Strength : 2057 lbf/in (18000 N/5cm)

Total weight w/ accessories : 1800 lbs (816 Kg)

TOW END VIEW

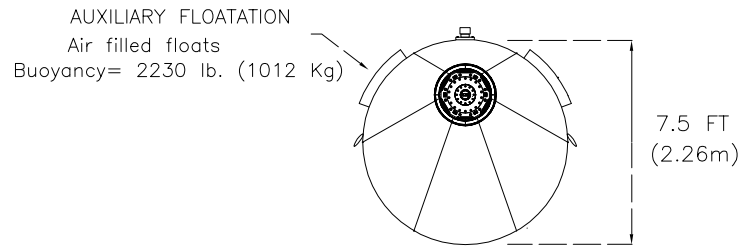

Cubic Meter	USA Gallons	Liters	Cubic Feet	Barrels		Project:"Sea Slug"		
						Ocean Towable Bladder oil spill recovery		
					Model FCB-125 for USCG			
50	13,200	50,000	1766	315	SCALE: N.T.S.	APPROVED:	Drawn by: FY	
					DATE: 05/12/06		REVISED: 07/01/07	
CANFLEX USA INC. PO BOX 1014 , 412 30th St , Anacortes,WA,98221,USA Tel:(206)282-8233 or (800)544-8356, Fax: (206)282-5933 or (800)635-8992; Web: www.canflexinc.com								

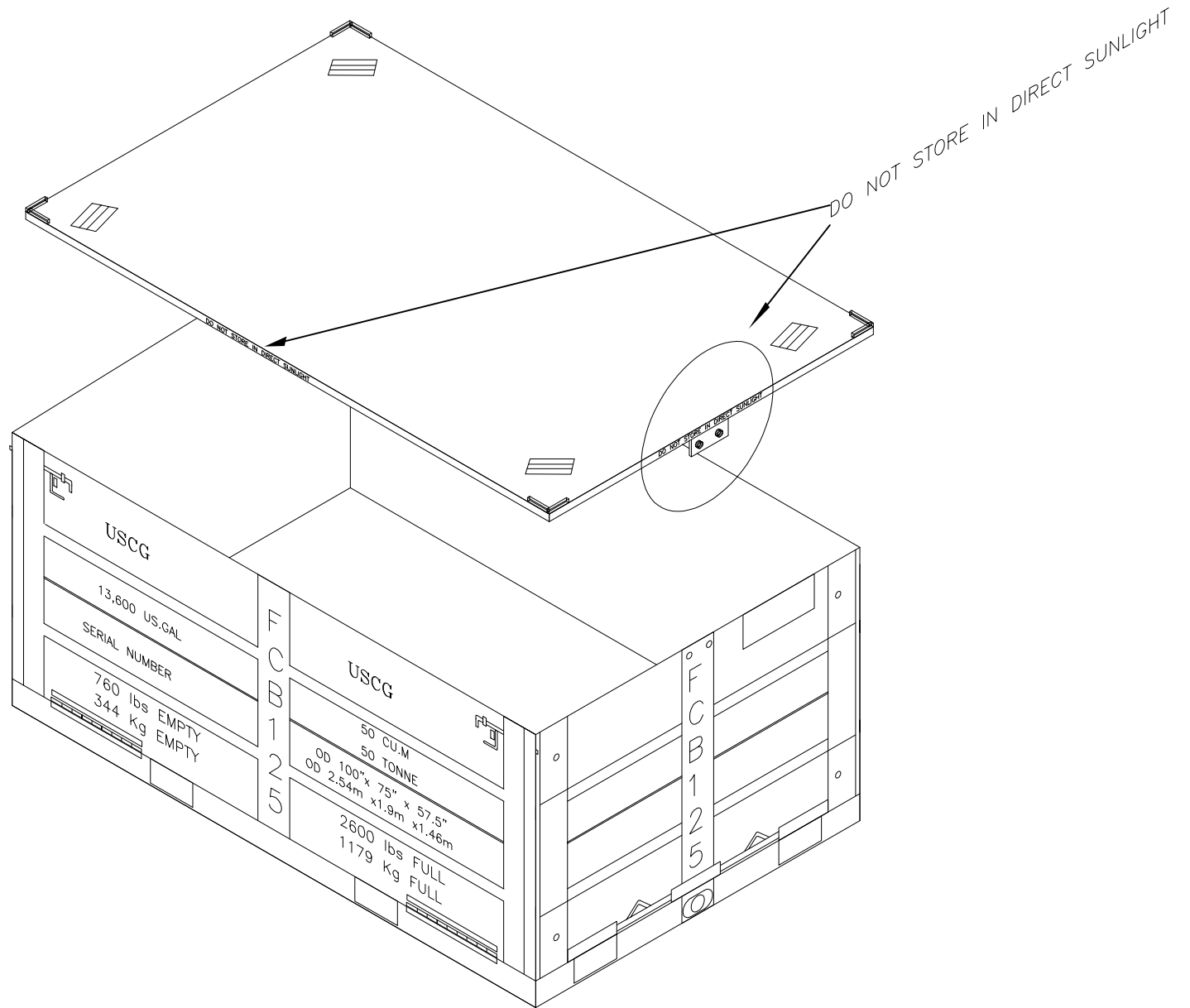

Dimensions:
 FCB- 125 : 1.9 m x 2.54 m x 1.46 m (high)
 or 8.33 ft x 6.25 ft x 4.79 ft (high)
 Material: 100% Anodized Marine Grade Aluminum



Project: FCB-125
 Aluminum Shipping On-site Storage Container
 SCALE: N.T.S. APPROVED: Drawn by: FY
 DATE: 12/22/03 REVISED:

CANFLEX USA INC. PO BOX 1014 412 30th St. Anacortes, WA. 98221
 Tel: (206) 282-1823 or (800) 544-1835. Fax: (206) 282-5933 or (800) 635-8992



CANFLEX (USA) Inc.

DATE: 09/22/07

FCB-125 & 250 USCG Style w/ 25" connection & Female Outlets

CHECK LIST

Model _____ Inspected by _____ Date _____

Serial # _____

Shipping to _____

PASS Q/C INSPECTION OF BAG _____

Weight _____

PASS Q/C INSPECTION OF NOSE CONE BLADDER W/ Monsun valve w/ internals and gasket _____

PASS Q/C INSPECTION FLOAT POCKETS W/ Monsun Valves internals and w/ internals & gaskets _____

PASS Q/C INSPECTION OF RELIEF VALVE @ 1PSI _____

Bladders – Bow to stern attached items (bolted, welded or shackled)

- ? One only tow bridle c/w 1" x 100 ft high strength rope tow line c/w bronze thimble eyes both ends, line is attached to tow bridle with 1-1/4" screw pin shackle
- ? One only 4" NPT male connection c/w PVC cap and lanyard located in center bladder nose cone
- ? One only 2" PVC filler /deflation fitting-Monsun valve w/ gasket- for nose cone

- ? One set double triangles welded to bladder – position top forward
- ? Four triangles welded on sides of bladder (2 per side) – position top forward. Purpose: Connected via 2” webbing to tow end bridle.
- ? One only 6” NPT male threaded connection c/w PVC cap and lanyard-function-“to accept 90 degree elbow and valve assembly for loading of bladder
- ? One only navigation light fixture welded to top of bladder
- ? One only 5” webbing lift straps to fit around bladder to help in launch/retrieval of bladder (belly band). (306 in for FCB-125 & 349 in for FCB-250)
- ? One only 4” NPT male connection c/w 2”relief valve set inside opening and also c/w PVC cap and lanyard
- ? One only triangle welded to top of bladder –forward of large center hatch
- ? One only **25 inch** hatch c/w cap and lanyard- purpose –“ to accept offload pump”
- ? One only triangle welded to top of bladder-to rear of large center hatch
- ? Only 4” NPT male connection c/w PVC cap and lanyard- purpose “ attach 4” PVC ball valve for vent when filling”
- ? One only 5” webbing lift straps to fit around bladder to help in launch/retrieval of bladder (belly band). (306 in for FCB-125 & 349 in for FCB-250)
- ? One only navigation light fixture welded to top of bladder
- ? One only 3” NPT male connection c/w lanyard – purpose “decant connection”
- ? One only set triangles welded to top stern of bladder
- ? One only 4” NPT female connection c/w **FEMALE camlok** located at apex stern cone
- ? One only stern harness same as bow tow and also c/w 1” x 100 ft high strength rope line c/w bronze thimble eyes both ends, line is attached to harness with 1-1/4 tonne screw pin shackle
- ? One only ½” diameter high strength Safety Line connected to forward triangle with 5/8” SS quick link, this line passes through both triangles located either side of top center hatch and terminates at rear triangle and attached with 5/8” SS quick link.

List of all unattached items included with the bladders to be attached before launch

- ? One only Drogue to attached to stern of bladder to control forward motion, drogue is c/w ½” x 50 ft rope line w/stainless swivel and rope float
- ? One only 27” buoy w/ strap -floatation to support stern cone
- ? One only 4” x 15 ft stern suction hose c/w male and female camlocks AND attached float
- ? One only 2” x 15-ft decanting hose with compression ftg. & threaded for connecting to ftg on bladder, c/w female cam-lock with 2” plug AND other end w/ male cam-lock.
- ? One only 6” male camlock w/ butterfly valve assembly X 6” - 90 degree female camlock
- ? 6” Female NPT thread X female cam-lock swivel
- ? 4” Female NPT thread X female cam-lock swivel
- ? One only 6” male cam-lock X 4” female cam-lock –REDUCER

- ? One 4" x 90 degree elbow – male camlock X female camlock- to accept smaller loading hose.
- ? One only 4" PVC ball valves c/w -male camlock X female camlock- to connect to 4" stern suction hose
- ? One only 4" PVC ball valve c/w -male camlock X female camlock- to connect to 4" connection at top forward position on bladder
- ? One only battery operated 5 ft high navigation marker light to attach to either forward or aft light mounts welded to top of bladder

Additional non-operational items included

- ? One only ground sheet
- ? One only 6" hand pump to inflate nose cone bladder and air floats if powered pump not available
- ? One certified load rated cargo net to enclose bladders in
- ? One 1-1/2" screw pin shackle for cargo net
- ? One only **aluminum shipping storage container** and side air vents
- ? Container replaceable liner w/ 2" UNION fttg
- ? One only One only air manifold c/w gauge to attached to air float filler valves if desired to inflate float tubes by this method
- ? Two 1-1/2" screw pin shackles for belly bands
- ? 1st Tool box:
 -
 - Five 3/8" screw pin shackles for container
 - Four certified set of container lift straps (9 ft for FCB-125 & 11 ft. for FCB-250)
 - Ten 10" container liner bungee cords
 - Four 31" long nav. night bungee cords
 - Four 24" long ties
- ? Only maintenance kit that contains following items (in 2nd tool box):
 - 1 x 16 oz. Can PVC patch cement (Not include if AIR Freight)
 - 1 x 24" x 24" coated bladder material
 - 2 x 10" circles same
 - 4 x 7" circles same
 - 4 x 7" circles float cover material
 - 1 knife
 - 1 roller for patch cement
 - 1 strap wrench to remove PVC caps on fittings if required
 - Manual

Labels

- ? Size and function of all top aluminum fittings
- ? Identification of navigation light mount and anchor points
- ? Each float cover shall be silk-screened with
- ? All handles (4 on top & 3 on each side) with "MAX SWL 500 LBS"
- ? Nose cone air valve with "AIR FILL ONLY"
- ? Nose cone with "MAX SWL 20,000 LBS LIFT HARNESS" (minimum 5:1 safety factor)
- ? Tail cone eye bolts with "NOT A LIFT POINT"
- ? All metal triangular grips with "MAX SWL 1000 LBS"

? Visual Inspection

? Notes :